

FLOWLINE FITTINGS

FLOWLINE & MANIFOLD FITTINGS FOR MUD SYSTEM

UNIONS

- Hammerseal Union
- Air-O-Grip Union & Air Tube
- Hammer Union & Seals
- Special Unions

MANIFOLD FITTINGS

- Swivel Joints
- Pup Joints
- Hose Loops
- Integral Fittings

EXPANSION JOINTS

- Rubber Expansion Joint
- Metal Expansion Joint / Sleeve Dresser
- Metal Bellows



HAMMERSEAL UNION

We are specialized in manufacturing hammer seal union, also named tank unions, size from 4" to 28", with butt welded connection. Kemper style Tank union or Hammer-seal Union is widely used for mud tank connecting lines, it is an updated design based on Air-O-Grip Union. Even if the tanks are not aligned perfectly, it still made up tight for a non-leak seal, and fast installation and un-install. We are aimed to provide a good structure with superior material to meet the requirement in the markets.

Features-

- Casting steel sub & nut, and molded nitrile O-ring (NBR) provides a compression seal
- Tank union accepts up to 7° pipe misalignment
- Available in 4, 6, 8, 10, 12- and 14-inch sizes, and large size or nonstandard size can be customized
- Adopt ANSI/EU Std. Butt-weld end connection, GB Standard available upon request
- Socket weld available to design if request
- Large diameter, medium-low voltage and frequently dismantling, rapid installation and dismantling
- Consistent to KEMPER Hammer-seal Union
- Grey or Red Nut & Sub, customized color & logo available

Technical Parameter-

- Working medium: Oil based mud, water-based mud or other drilling fluid
- Medium temperature: 0°C ~ 90°C, Viton seal for Hi-temp.
- Ambient temperature: -40°C ~ 55°C
- Sealing fluid pressures up to 150psi

Specification-

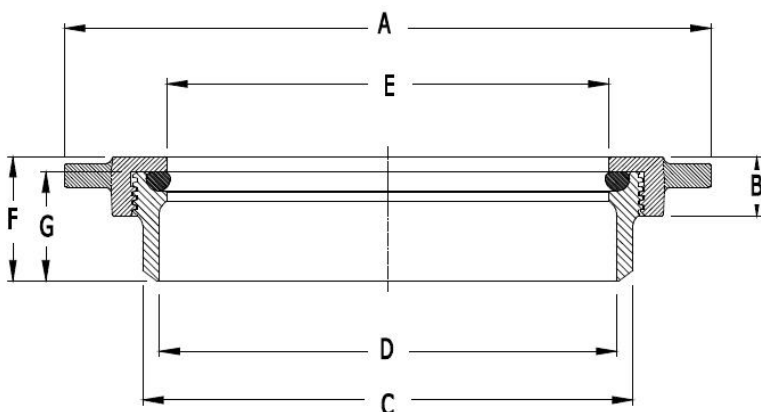

Type	Connect Pipe O.D.	Female Sub * Weld to	Dimensions in mm						
			A	B	C	D	E	F	G
4-inch	4 ½"(114.3mm)	6"	10.75	2	6.63	5.88	4.81	5	4.5
6-inch	6 5/8"(168.3mm)	8"	13.5	2	8.63	7.88	6.88	5	4.5
8-inch	8 5/8"(219.1mm)	10"	15.75	2	10.75	10	8.88	5	4.5
10-inch	10 3/4" (273.1mm)	12"	17.75	2	12.75	12	11	5	4.5
12-inch	12 3/4"(323.9mm)	14"	19.75	2	14	13.25	13	5	4.5
14-inch	14" (355.6mm)	16"	22	2	16	15	14.25	5	4.5
16-inch	16" (406.4mm)	18"	24	2.25	18	16.5	16.25	5	4.5
18-inch	18" (457mm)	20"	26	2.25	20	18.8	18.25	5	4.5
20-inch	20" (508mm)	22"	28	2.25	22	20.8	20.25	5	4.5
22-inch	22" (559mm)	24"	30	2.25	24	22.8	22.25	5	4.5
24-inch	24" (610mm)	26"	32	2.25	26	24.8	24.25	5	4.5
26-inch	26" (660.4mm)	28"	34	2.25	28	26.8	26.25	5	4.5

Note:

* Female Sub Welding Size is designed according to the actual welding request, Butt-weld inside diameter (C) dependent on pipeschedule.

** Size 16-inch and above size needs to customize and confirm the drawing.



AIR-O-GRIP UNIONS / PNEUMATIC TYRE UNION

Air Grip Unions are widely used in the pipelines with low-pressure, large pipe size, big pipe misalignment, frequent installation and uninstal. Especially, in connecting mud tanks, mud suction and return lines in solid control system. Size from 4"to 26" available, and air tube can be customized up to 46".

Features

- Fast, easy make-up without closealignment
- Carbon steel body welds in place on mud tanks, with NBR air tube for sealing even if the pipe is not perfectlyaligned
- Allows pipe expansion or misalignment up to14°
- No nuts, bolts, or wrenchesrequired
- KEMPER Seal-O-Grip Unionstyle
- Grey or Red Nut & Sub, customized color & logoavailable



Technical Parameter

- Working medium: Oil based mud, water based mud, or other drillingfluid
- Medium temperature:-45°C~55°C
- Reconversion time when deflated: 1-3seconds
- Line pressure up to 150psi and tube pressure is Max. 50psi above than linepressure
- Structure: Casting Steel Shell and Air Inflatable Tube(NBR)

Specification



Line Pipe Size	Line Pipe O.D.	Max. Misalignment Tolerance	Dimensions in mm						
			A	B	C	D	E	F	G
4-inch	4 1/2" (114.3mm)	7°	4 19/32	4 19/32	5 1/6	5 3/4	6 5/8	3	2
6-inch	6 5/8" (168.3mm)	14°	6 3/4	6 15/16	8	8 5/8	10 1/4	4	2
8-inch	8 5/8" (219.1mm)	14°	8 3/4	8 15/16	10 1/8	10 3/4	12 1/4	4	2
10-inch	10 3/4" (273.1mm)	14°	10 15/16	11 1/8	12 1/8	12 3/4	14 1/2	4 1/4	2
12-inch	12 3/4" (323.9mm)	14°	12 15/16	13 1/8	13 3/8	14 1/4	16 1/2	4 1/4	2
14-inch	14" (355.6mm)	14°	14 1/8	14 1/4	14 1/4	16 1/4	18 1/4	4 1/2	2
16-inch	16" (406.4mm)	14°	16 1/8	16 1/4	16 1/4	18 1/4	20 1/4	5 1/8	2



WING UNIONS / HAMMER UNIONS

Wing Unions are widely used in the fluid or mud manifolds, Cementing and choke-and-kill lines; it was divided by union color code, to use for lower-pressure, middle-pressure and high-pressure standard trim or H2S trim. We also manufacture compatible Hammer Union Seals (Lip Seal), O-ring, Lip seal rings, stainless steel backed seal rings, and brass backed seal rings for Weco Wing Union.



Features

- Adopted high strength alloy steel/carbon steel appropriate to specific pressure rating, strict heat treatment technique, rigid quality control as per API Spec 16C;
- Equivalent to FMC WECO style Hammer Union with identical size to ensure easy replacement;
- API Standard LP/NPT, Tubing threaded, and butt-weld end connection available;
- Complete line of standard service and sour gas wing unions in size from 1"-12" with working pressure up to 20000psi, Sour service conform to NACE specification;
- Quality and full style of hammer union seals can be provided in Buna-N, Viton, and Buna-N/Viton with a brass ring, Buna-N/Viton with a stainless steel ring, and Teflon. There are 80 Nitrile, 80 Viton, 90 Viton or upon request.
- The same figure number, size, and pressure rating are interchangeable, making it easy to match male and female subs that are frequently made-up and broken-out.

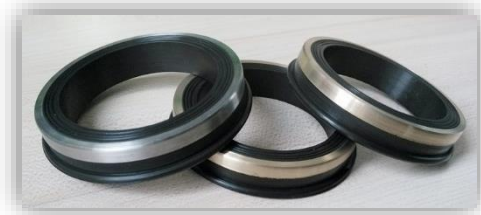

Wing Unions for Low Pressure Service 1000 - 2000psi

Feature-

Spherical surface of male sub and conical surface of female sub to form a metal-to-metal seal
Ball-and-cone seal remains leak-proof even when one surface is slightly pitted or misaligned

Figure 100

- ✓ Recommend for air, water, gas and oil service to 1000psi cwp manifold and line connection
- ✓ An economical low-pressure union
- ✓ Size from 2"-8"
- ✓ API standard thread and butt-weld end connection
- ✓ Black Nut & Yellow Sub



Figure 200

- ✓ Recommend for air, water, and oil or gas service to 2000psi cwp general service manifold and lineconnection
- ✓ Size from 1"-10"
- ✓ API standard thread and butt-weldend connection available for 2" and above
- ✓ Blue Nut & Grey Sub

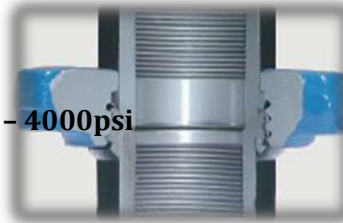

Wing Unions for Medium Pressure Service 2000 – 4000psi

Feature-

Metal-to-metal seal with a resilient O-ring in the male sub, the replaceable O-ring extends union life and protect the metal-to-metal against corrosion.

Figure 206

Recommend for air, water, and oil or gas service to 2000psi cold working pressure manifold and line connections and corrosion service
Size from 1"-10"

Buna-N O-ring in male sub provides an additional sealing and protect metal-to-metal seal

API standard thread and butt-weld end connection available for 2" and above

Blue Nut & Grey Sub

Subs and nuts of Fig.206 are interchangeable with Fig.200



Figure 207 Blanking Union

- ✓ Recommend for air, water, and oil or gas service to 2000psi CWP to seal manifold connections and protect unionthread
- ✓ Size 3", 4", 6"
- ✓ Buna-N O-ring in male sub provides an efficient sealclosure
- ✓ API standard thread and butt-weld end connection available
- ✓ Blue Nut & Grey Sub
- ✓ Subs and nuts of Fig.207 are interchangeable with Fig.200, Fig.206



Figure 211 Insulating Union

- ✓ Recommend for 2000 psi cold working pressure production systems with electrolytic corrosion problems
- ✓ Size from 1" - 4"
- ✓ Laminated insulating rings provide 35 million Ohms resistance across the union
- ✓ Buna-N O-ring in male sub provides a positive primary seal and seal ring in female sub as a secondary seal
- ✓ All insulating rings, O-ring and seal ring can be replaced
- ✓ API standard thread and butt-weld end connection available
- ✓ Blue Nut & Grey Sub



Figure 400

- ✓ Recommend for 2 1/2" - 12" air, water, oil or gas manifold and line connection, general service and sour gas service
- ✓ 4000psi CWP for 4" below and 2500 psi over 4" to 12"
- ✓ Ball and cone seating surface for easy alignment and dependable pressure seal
- ✓ 2" available with a lip-type seal
- ✓ API standard thread and butt-weld end connection available

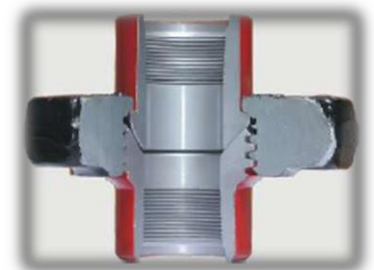

- ✓ Black Nut & RedSub



Wing Unions for High Pressure service 6000 - 20000psi

Feature-

Sealing with a replaceable lip-type seal ring in the female sub, this primary seal protects the secondary metal-to-metal seal from abrasion and corrosion while minimizing flow turbulence

Figure 600

- ✓ Recommend for air, oil, gas or steam service to 6000psi cold working pressure manifold, line connection for drilling, wellservicing
- ✓ Size from 1" -4"
- ✓ Rugged and fast 2 pitch acme thread make it quickest union
- ✓ Fitted with a bronze seal insert as primary seal, not rust in waterservice
- ✓ API standard thread and butt-weldend connection available
- ✓ Black Nut & SilverSub

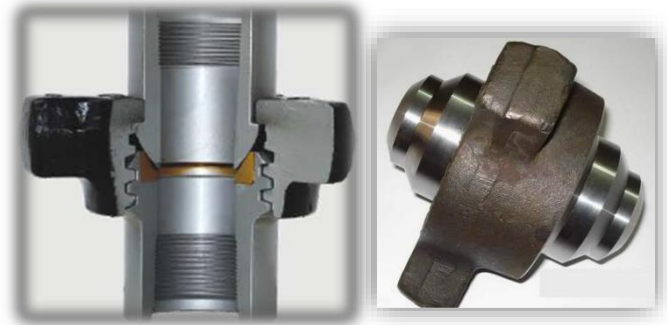

Figure 602

- ✓ Recommend for air, oil, gas or steam service to 6000psi cwp manifold, line connection and mudservice
- ✓ Size from 1" -4"
- ✓ Replaceable lip-type seal provides primary seal, protect metal-to-metal seating surface
- ✓ Available for sour gasservice
- ✓ Smaller than lighter than Fig.600, recommend for truck mounting where size and weight are critical
- ✓ API standard thread and butt-weldend connection available
- ✓ Black Nut & OrangeSub



Figure 1002

- ✓ Recommend for high pressure manifold system, cementing, fracturing, acidizing, testing and choke kill lines; 10000psi cwp through 4", and 7500 psi cwp for 5" and 6"
- ✓ Size from 1" - 6"
- ✓ Replaceable lip-type seal (Buna-N) provides primary seal, protect secondary metal-to-metal seating surface, 5" and 6" have O-ring for primary seal
- ✓ Available for sour gas service
- ✓ API standard thread and butt-weld end connection available
- ✓ Red Nut & Blue Sub

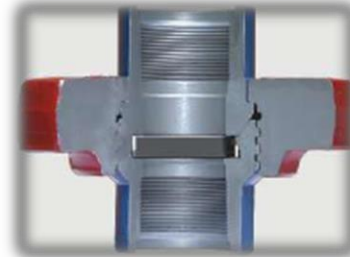

Figure 1003 Misaligning Union

- ✓ Recommend for high pressure connections where lines can't be aligned, 10000psi cwp for 2" and 3", 7500psi cwp for 4" and 5"
- ✓ Size from 2" - 5"
- ✓ Ball seat provides positive seal with up to +/- 7.5° misalignment
- ✓ Available for sour gas service
- ✓ Replacement O-ring one male sub provides primary seal, to protect metal-to-metal seal against abrasion and corrosion
- ✓ API standard thread and butt-weld end connection available
- ✓ Black Nut & Green Sub

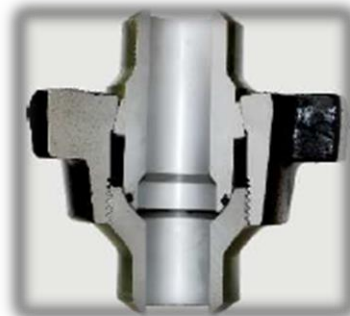

Figure 1502

- ✓ Recommend for air, water, oil, gas and mud service 15000psi CWP cementing, fracturing, acidizing, testing and choke kill lines
- ✓ Size from 1" - 5"
- ✓ Available for sour gas service up to 10000psi
- ✓ Replacement lip-type seal provides primary seal (Buna-N), to protect metal-to-metal seal against abrasion and corrosion
- ✓ API standard thread and butt-weld end connection available
- ✓ Blue Nut & Red Sub

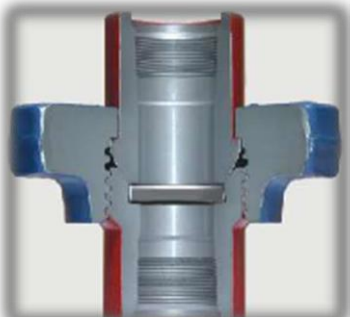
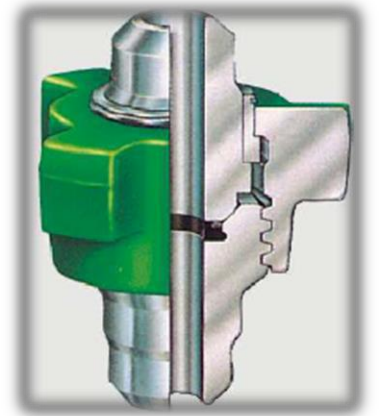

Figure 2002

- ✓ Recommend for 20000 psi cold working pressure standard service cementing, fracturing, acidizing, testing and choke killlines
- ✓ Size from 2", 3"
- ✓ Replacement lip-type seal provides primary seal (Buna-N), to protect metal-to-metal seal against abrasion and corrosion
- ✓ Butt-weld end connection only
- ✓ Green Nut & Green Sub
- ✓ Figure 2202 for sour gas service, up to 15000 psi, size from 2" and 3" available in butt-weld only, MR-01-75 standard



Wing Unions for Sour Gas Service

Figure 400, Figure 602, Fig.1002, Fig.1003, Fig.1502, Fig.2202







SPECIAL UNIONS

We also supply all kinds of special unions, including Union Crossovers, Union Reducing Crossovers, Nylon Union, Stainless Steel Union, Self-sealing Union, BOP hose connectors, Flange Crossover Union, Female Union Bull & Female Gage Plugs with ½" NPT, Male Bull, Male Gage Plug with ½" NPT, etc.



SWIVEL UNIONS

We could supply series of integral forged high pressure pipe fittings for Flowline Fittings and Manifolds in accordance with API 6A, 16C. Including hammer union, union crossover adaptors, union bull, bull plug, tee, cross, 5-block, 6-block, Flange to wing adapters, wing to wing adapters, flange to union crossover, long-radius swivel joint, short-radius swivel joint, pup joints, cementing & circulating hoses incorporate swivel joint, steel hose loop, all these parts are alloy steel integral forged, with reliable performance to suit any high pressure condition.

LONGSWEEP SWIVEL UNIONS

Long-radius Swivel Joint is metal pipe joints with ball bearings to realize 360 degree rotating, designed basing on US FMC Chiksan Swivel Joint, especially for abrasive applications such as fracturing, choke-and-kill lines, cementing and circulating hoses, acidizing, and test lines; for high pressure and Extra high pressure from 6000 to 20000psi with Union and Female line pipe threads end connections in Silver, Olive Green, Black, Red, Light Blue. There are 9 basic styles or configurations. These styles permit 360degree rotation and movement in one, two, or three planes, and can be assembled using two or more standard pieces.

Technical Parameter-

- ✓ Working Pressure Scope:42Mpa-140Mpa

- ✓ Nominal Size:1"-4"
- ✓ Working Temperature: -29-121C° (PU)
- ✓ Medium: Standard Trim orH2S
- ✓ Standard: API Spec 16C or NACE MR0175
- ✓ Standard Model including:
 - Style 10 F x M, M xM
 - Style 20 F x M, M x M
 - Style 30 F x M, M x M
 - Style 40 F x M, M x M
 - Style 50 F x M, M x M
 - Style 60 F x M, M x M
 - Style 70 F x M, M x M
 - Style 80 F x M, M x M Style 100 F x M, M x M



We still supply Swivel Joint Repair kit for Standard or H₂S service, which includes packing set, ball plug, steel balls, setscrew, O-ring, lube plug, snap ring, greaseretainer.



PUP JOINTS

We provides one-piece alloy steel flow line piping with wing union connection, each pup joints with integral, welded, or NPST unions end connection , available in lengths to 10 ft to handle fluid from 10000 to 15000 psi for standard and sour service. They are used for high pressure discharge line or choke and kill line.



Technical Parameter-

- ✓ Working Pressure Scope: 35Mpa-140Mpa
- ✓ Nominal Size: 2"-4"
- ✓ Length: 48in, 60in, 72in, 96in, 120in
- ✓ Working Temperature: -29-121C° (PU)
- ✓ Medium: Standard Trim or H₂S
- ✓ Standard: API Spec 16C or NACE MR0175



HOSE LOOPS

We could provide high pressure Chiksan style cementing and circulating hoses (Longsweep Hose) incorporate swivel joints of forged alloy steel with superior quality hardened ball races and high pressure type packing units. It can handle a complete range of fluids up to 15000 psi cw, all material adopted meet the API 16C standard. Recommend used for high pressure flowline, cementing and circulating lines standard and sour gas service.

Technical Parameter-

- ✓ Working Pressure Scope: 6000-15000psi
- ✓ Nominal Size: 1"-4"
- ✓ Spec. size: 2" x 10', 2" x 12', 3" x 12'

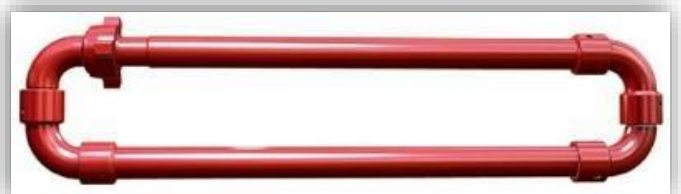

- ✓ Working Temperature: -29-121C° (PU)
- ✓ Medium: Standard Trim or H2S
- ✓ Standard: API Spec 16C or NACE MR0175
- LS-15/LSG-15 Longsweep hose
One wing union and one each style 50 and style 10 longsweep swivel joint with integral wing union end
- LS/LSG-10 Longsweep hose
Four wing union and two style 50 or style 10 longsweep swivel joints with integral wing union ends.
- TS-15 Longsweep hose
Four wing union and two style 50 or style 10 longsweep swivel joints with integral wing union ends.

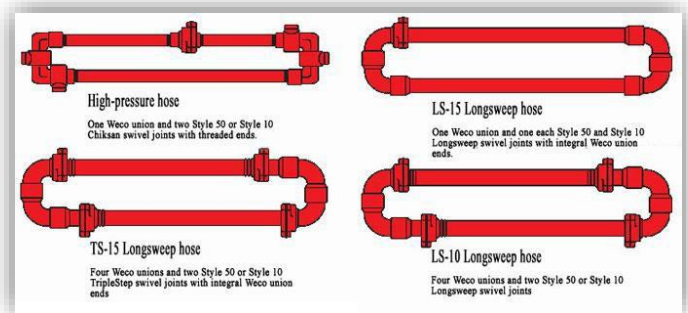

INTEGRAL FITTINGS

We supplies series of high pressure integral fittings and welded fittings, including Elbows, Tees, Crosses, Laterals and Wyes with size ranging from 2"-4" and pressure from 3000psi to 20000psi. The integral connections made of high strength alloy steel heat-treated with strong strength and longer service life. Weco wing union end or welded end, special connections are available upon request. All is designed and inspected in accordance with API Spec 6A.



Also provides OTECO style manifold fitting with standard LP thread or Schedule XX or 160 buttweld end connections in 2", 3", 4", 5" standard 5000psi working pressure or 7500psi high pressure. All fittings are hydrostatically tested prior to shipment and full certification can be supplied upon request. Include:

- 45° Long SweepElls
- 90° Long SweepElls
- 90° Long Sweep Ells with 2 in.outlet
- 160° StandpipeGooseneck
- 160° Standpipe Gooseneck with topoutlet
- 180° StandpipeGooseneck
- Long Sweep Full FlowCross
- Long Sweep Full FlowTee
- Long SweepTee
- Long SweepY

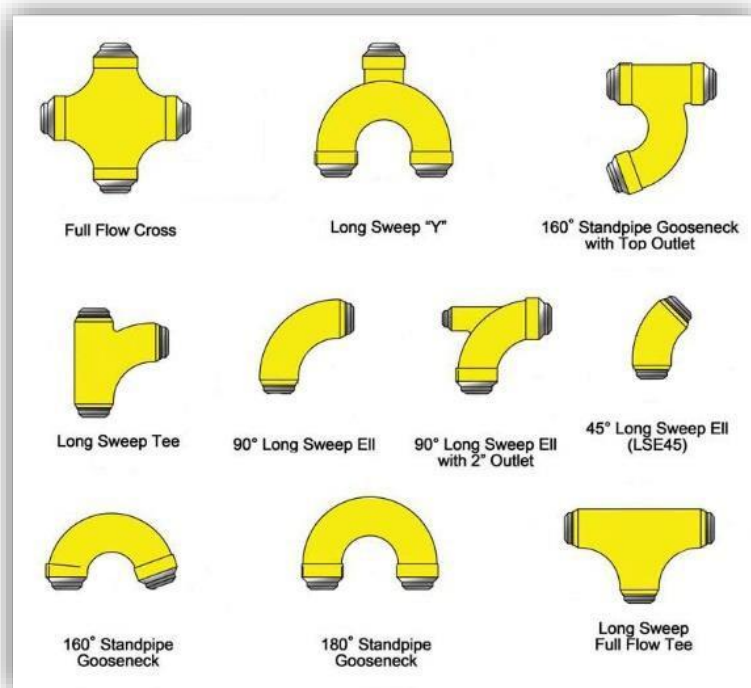

FLEXIBLE RUBBER EXPANSION JOINT (SINGLE ARCH)

- A kind of rubber coupling with good elasticity, high air tightness, good shock absorption and noise reduction effect to be used for pipeline with high pressure and large compensation displacement, easy installation;
- Adopt new technology of gas blowing mold, consisting of fabric rubber sphere and loose flange;
- No gaskets required, integral rubber flanged design, Flange adopted according to DIN PN16/10, ANSI 150/250/300 lbs., BS, JIS10K.



Diagrammatic Drawing & Technical Parameter

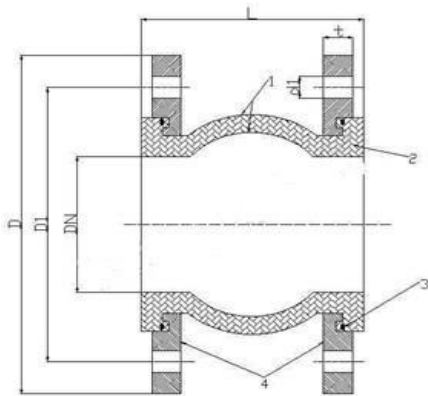

No.	Part	Material
1	Body	NR,CR,IIR,NBR,FKM,EPDM
2	Inner & Outer Rubber	NR,CR,IIR,NBR,FKM,EPDM,PTFE
3	Body Support	Nylon cord fabric
4	Reinforcing Ring	Multi-strand coppering steel wire
5	Flange	CS Q235, 304SS, 316SS, Plastic
Working Pressure		1.0 - 2.5Mpa
Burst Pressure		2.0 - 4.5Mpa
Vacuum		400-750Kpa
Working Temperature		-30~+250℃
Application		Air, Water, Sea Water, Oil, Acid, Alkali, etc.

DN		Length	Axial Displacement mm		Horizontal Displacement mm	Angular Deflection (a1+a2)°
mm	inch	mm	Extension	Compression		
32	1.25	95	6	9	9	15
40	1.5	95	6	10	9	15
50	2	105	7	10	10	15
65	2.5	115	7	13	11	15
80	3	135	8	15	12	15
100	4	150	10	19	13	15
125	5	165	12	19	13	15
150	6	180	12	20	14	15
200	8	210	16	25	22	15
250	10	230	16	25	22	15
300	12	245	16	25	22	15
350	14	255	16	25	22	15
400	16	255	16	25	22	15
450	18	255	16	25	22	15
500	20	255	16	25	22	15
600	24	260	16	25	22	15
700	28	260	16	25	22	15
800	32	260	16	25	22	15
900	36	260	16	25	22	15
1000	40	260	18	26	24	15
1200	48	260	18	26	24	15
1400	56	350	20	28	26	15
1600	64	350	25	35	30	10



METAL EXPANSION JOINT SSJA (AF) DISMANTLING JOINT

- Same sealing principle as SSJB(AY) Gland Loosing Expansion Joint, one endwiththeintegralflangeconnectionandthesocketconnectionatthe otherend;
- Compensate the pipeline axial displacement, angle deflection, misaligned and protect the valve and otherequipment;
- Reasonable structure design with gasket for sealingfunction;
- To reduce the vibration and noise to ensure the securityoperation.



Diagrammatic Drawing & Technical Parameter

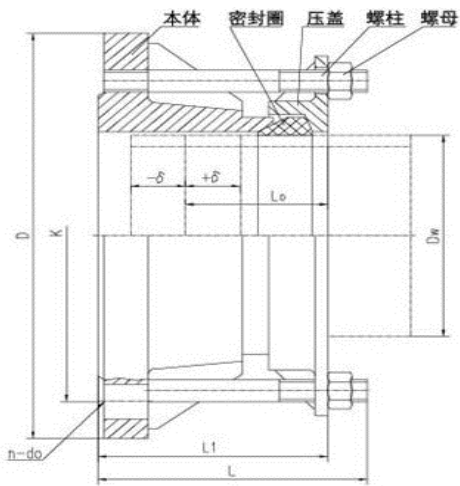

No.	Name	Qty.	Material
1	Body	1	Carbon Steel QT400-15, Q235A, ZG230-450, 1Cr13 20
2	Cover	1	Carbon Steel QT400-15, Q235A, 20, ZG230-450, 1Cr13
3	Gasket	2	NBR, CR, FPM, NR
4	Bolt	n	Carbon Steel Q235A, 25, 1Cr18Ni9Ti
5	Nut	n	Carbon Steel Q235A, 20, 1Cr18Ni9Ti

DN(mm)	Insert	Expansion δ	Deflection	Eccentricity
65-250	70mm	$\pm 45\text{mm}$	3°	3mm
300-700	85mm	$\pm 55\text{mm}$		4mm
800-3000	110mm	$\pm 75\text{mm}$		5mm
3200-4000	140mm	$\pm 130\text{mm}$		6mm

400	406			540	495	16-22	540	495	16-22	565	515	16-22
	426											
450	457			595	550	16-22	595	550	16-22	615	565	16-26
	480											
500	508			645	600	20-22	645	600	20-22	670	620	20-26
	530											
600	610			755	705	20-26	100	705	20-26	780	725	20-30
	630											
700	720			860	810	24-26	860	810	24-26	895	840	24-30
800	820			225		975	920	24-30	975	920	24-30	1015
900	920	1075	1020				1075	1020		1115	1015	28-33
1000	1020	1175	1120			28-30	1175	1120	28-30	1230	1160	28-36
1200	1220	1375	1320			32-30	1405	1340	32-33	1455	1380	32-40
1400	1420	270		1575	1520	36-30	1630	1560	36-36	1675	1590	36-42
1600	1620			1790	1730	40-30	1830	1760	40-36	1915	1820	40-48
1800	1820			1990	1930	44-30	2045	1970	44-40	2115	2020	44-48
2000	2020			2190	2130	48-30	2265	2180	48-42	2325	2230	48-48
2200	2220	275		2405	2340	52-33	2475	2390	52-42	2550	2440	52-56
2400	2420			2605	2540	56-33	2685	2600	56-42	2760	2650	60-56
2600	2620	240300		2805	2740	60-33	2905	2810	60-48	2960	2850	60-56
2800	2820			3030	2960	64-36	3115	3020	64-48	3180	3070	64-56
3000	3020			3230	3160	68-36	3315	3220	68-48	3405	3290	68-60
3200	3220			3430	3360	72-36	3525	3430	72-48			
3400	3420			3630	3560	76-36	3735	3640	76-48			
3600	3620			3840	3770	80-36	3970	3860	80-56			
3800	3820			4045	3970	80-39						
4000	4020			4245	4170	84-39						

Metal Expansion Joint SSJB(AY)								
DN	Dw	Length			N-Th			
		Length		D	0.25-1.6MPa	2.5-6.4MPa		
		L1	L					
65	76	180	208	155	4-M12	4-M12		
80	89			165				
100	108			195				
	124			195				
125	133			225				
125	140			225	4-M16			
150	159			220	220	255	4-M16	6-M16
	168					255		
200	219					310		
225	245					335		
250	273	223	223	375	6-M20	8-M20		
300	325	220	273	440	8-M20	10-M20		
350	355			490				
	377			490				
400	406			540				
	426			540				
450	457			590				
	480			590				
500	508			645	10-M20	12-M20		
	530			645				
600	610			750				
	630	750						
700	720			855	12-M20	14-M20		
800	820	355	355	970	12-M24	16-M24		
900	920			1070	14-M24	18-M24		
1000	1020			1170				
1200	1220			1405	16-M24	20-M24		
1400	1420	290	377	1590	18-M24	28-M27		
1500	1520			1690				
1600	1620			1795	20-M27	28-M27		
1800	1820			2000	22-M27	30-M30		
2000	2020			2200	24-M27	32-M30		
2200	2220	400	400	2420	26-M30			
2400	2420			2635	28-M30			
2600	2620			2835	30-M30			
2800	2820			3030	32-M33			
3000	3020			3240	34-M33			

3200	3220	400	3440	36-M33	
3400	3420		490	3640	38-M33
3600	3620	500		3860	40-M33
3800	3820		4080	40-M36	
4000	4020		4300	42-M36	

METAL BELLOWS

EXPANSION JOINT

- Composed of a metal bellows and flange, which can compensate the pipeline's axial, lateral and angular displacement by thermal and mechanical deformation, and absorb a variety of mechanical vibrations, to reduce distortion and prolong the pipeline's service life;
- U-shaped, Ω-shaped, S-shaped, V-shaped, divided by structure, U-shaped is popular;



- Mainly used to compensate for axial or lateral displacement

Diagrammatic Drawing & Technical Parameter

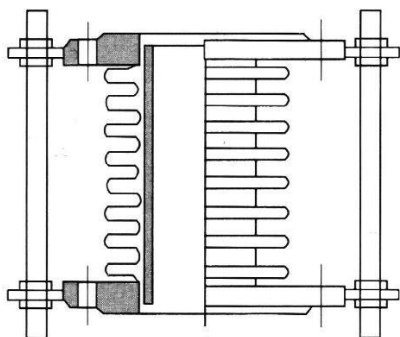

Model	BTJDZ
Material	Carbon Steel, Stainless Steel, Ductile
Working pressure	0.1-2.5 Mpa
Nominal Diameter	D100-D3000 mm
Times Fatigue life	1500 h
Applicable Temperature	-20°C ~ +450°C
Applicable Medium	Air, Water, Sea Water, Oil, Acid, Alkali,

DN	Number of wave	Pressure grade Mpa					Available area of bellows c m ²	Max size of external diameter mm	Length	
		0.25	0.6	1.0	1.6	2.5			Flange JDZ/F(mm)	Connection Tube JDZ/F(mm)
		Axial compensation mm, f911N/ram								
32	8	25/21	22/26	20/26	18/63	15/98	16	110	160/250	264/210
	16	50/11	46/14	41/14	36/32	31/47		220	224/291	316/320
40	8	25/28	22/44	20/44	18/89	15/106	23	130	164/259	269/260
	16	50/14	46/22	41/22	36/45	31/55		240	230/304	319/400
50	8	25/30	22/51	20/70	18/70	15/138	37	150	172/276	282/230
	16	50/16	46/26	41/35	36/35	31/70		260	240/342	347/450
65	8	33/28	30/35	26/44	22/55	19/68	55	170	315/294	300/260
	12	42/16	38/22	38/32	34/40	29/50		280	260/334	340/470
80	8	40/20	36/26	34/33	28/41	24/54	81	200	240/338	344/260
	10	53/14	49/17	49/21	43/26	38/33		230	270/368	374/300
100	8	45/47	45/60	40/75	35/93	29/117	121	220	235/317	323/280
	10	76/26	74/32	64/40	57/50	49/63		260	305/381	387/320

125	6	48/38	42/47	38/59	34/74	29/92	180	250	282/314	316/320
	8	85/23	77/29	66/36	58/45	50/56		290	382/386	388/360
150	6	49/42	44/50	40/62	34/78	29/97	257	250	282/339	338/320
	8	79/34	71/43	64/51	54/59	46/65		290	356/399	402/360
200	6	52/49	46/55	42/68	38/78	34/111	479	300	280/348	348/370
	8	73/31	65/44	59/52	53/58	48/78		340	340/402	402/420
250	6	72/30	63/34	59/42	52/45	47/55	769	300	315/379	415/420
	8	108/16	97/21	87/35	79/39	71/47		360	393/459	493/460
300	6	72/51	65/55	59/59	52/65	47/71	1105	340	366/427	466/488
	8	108/32	97/35	87/37	79/41	71/45		400	464/525	564/520
350	6	72/58	65/62	59/67	52/74	47/81	1307	340	397/452	497/480
	8	10/38	7/41	87/44	79/48	71/47		420	509/564	609/540
400	6	72/54	65/58	59/62	52/68	47/75	1611	340	412/478	512/480
	8	108/36	97/39	87/43	79/47	71/52		420	522/588	622/560
	6	108/32	97/35	87/37	79/41	71/45		340	403/498	503/500

450	8	162/20	145/22	131/23	118/25	106/28	1972	450	503/658	603/590
500	6	108/59	97/64	87/68	79/75	71/82	2445	340	431/523	531/500
	8	162/34	145/37	131/39	118/43	106/48		450	531/665	631/600
600	6	108/74	97/80	87/85	79/94	71/103	3534	380	478/548	578/540
	8	162/42	145/45	131/49	118/53	106/60			658/679	758/640
700	4	108/67	97/72	87/77	79/85	71/95	4717	1110	490	550
	6	162/42	145/45	131/49	118/53	106/60			690	670
800	4	120/88	108/95	102/102	94/112	82/123	5822	1265	502	560
	6	183/67	164/72	156/77	144/85	125/93			610	600
900	4	120/84	108/90	102/97	94/107	82/117	7620	1186		620
	6	183/60	164/65	156/69	144/76	125/84				720
1000	4	120/91	108/98	102/105	94/166		9043	1286		690
	6	183/59	164/65	156/71	144/81					790

Notes: If order,

1. Please confirm the length, connection flangesize;
2. Specify the medium or rubbermaterial;
3. Specify the medium temperature & workingpressure;

4. Customized



size acceptable.